

2

Bolero 1 Bolero 2



Operator manual
Mode d'emploi Opérateur
Operator Handbuch
Operator handleiding
Driftmanual
Operatorhåndbok
Betjeningsvejledning
Operaattorin käsikirja
Manual del operador
Manual do operador
Manuale per l'operatore
Εγχειρίδιο χειρισμού
Provozní příručka
Instrukcja obsługi
Manualul operatorului
Руководство оператора
Operatör kilavuzu
操作手冊
操作マニュアル
동자 설명서





English
Français
Deutsch
Nederlands
Svenska



Norsk
Dansk
Suomi
Español
Português

Information Information Information Informatie Information		Informasjon Information Informaatio Información Informação
Table of contents Table des matières Inhaltsangabe Inhoudsopgave Innehållsförteckning		Innholdsfortegnelse Indholdsfortegnelse Sisällysluettelo Contenido Índice
Installation Installation Installation Installeren Installation		Installasjon Installation Asennus Instalar Instalação
Programming Programmation Programmieren Programmeren Programmering		Programmering Programmering Ohjelmointi Programar Programação
Descaling Détartrage Entkalkung Ontkalken Avkalkning		Rensing Afkalkning Kalkinpoisto Descalcificación Descalcificação
Safety book Sommaire des sécurités Sicherheitsvorschriften Veiligheidsboek Säkerhetsföreskrifter	 700.403.347	Sikkerhetsbok Sikkerhedsbog Turvallisuuohjeet Libro de seguridad Instruções de segurança
User manual Mode d'emploi Utilisateur Gebraucher Handbuch Gebruiksaanwijzing Användarmanual	 700.403.564	Brukerhåndbok Brugsanvisning Käyttäjän käsikirja Manual del usuario Manual do operador

List of ingredients Liste des ingrédients Produktliste Ingrediëntenblad Ingredienslista		Ingrediensliste Ingrediens liste Ainesosaluettelo Lista de ingredientes Lista de ingredientes
Wait Patienter Warten Wachten Vänta		Vent Vent Odota Esperar Aguardar
Safety gloves Gants de sécurité Schutzhandschuh Veiligheidshandschoenen Skydds handskar		Hansker Sikkerheds handsker Suojahanskat Zapatos de seguridad Luvras de protecção
Safety goggles Lunettes de sécurité Schutzbrille Veiligheidsbril Skydds glasögon		Vernebriller Sikkerhedsbriller Suojalasit Gafas de seguridad Óculos de protecção
Hot liquid Liquide chaud Heiße Flüssigkeit Hete vloeistof Varma drycker		Varm væske Varm flydende Kuumaa nestettä Líquido caliente Líquido quente
Counter Compteur Zähler Teller Räknare		Telleverk Tæller Laskin Contador Contador
Accessories Accessoires Zubehör Toebehoren Tillbehör		Tilbehør Valgbar Lisälaitteet Accesorios Accessórios
Optional Option Produktliste Optioneel Tillval		Valgfri Tilbehør Valinnainen Opcional Opcional

it : Per la Sua lingua consultare la fine di questo documento.
 el : Στην αναδιπλωμένη σελίδα, στο τέλος του εντύπου, μπορείτε να κοιτάξετε για τους όρους στη γλώσσα σας.
 cz : Volba jazyka je popsána na konci následující stránky tohoto návodu.
 pl : Szukaj swojego języka na ostatnich stronach dokumentu.
 ro : Citiți pentru limba dvs pagina atașată la spatele acestui document.
 ru : Вкладыш на Вашем языке в конце этого документа.
 tr : Diliniz için arkadaki katli sayfaya bakınız.
 ch : 查看背頁的所屬語文
 jp : 各言語についてはこの説明書の最後のページをご参照ください。
 kor : 자료의 뒷면 접은페이지에서 해당언어를 참조 하시오



Installation
Installation
Installation
Installeren
Installation

Installasjon
Installation
Asennus
Instalar
Instalação

Installazione
Εγκατάσταση
Instalace
Instalacja
Operare

Установка
Yerleşirme
安裝
設置
설치

1



Programming
Programmation
Programmieren
Programmeren
Programmering

Programmering
Programmering
Ohjelmointi
Programar
Programação

Programmazione
Προγραμματισμός
λειτουργίας
Programování
Programowanie
Programare

Программирование
Programlama
程式
プログラミング
프로그램

7



Descaling
Détartrage
Entkalkung
Ontkalken
Avkalkning

Rensing
Afkalkning
Kalkinpoisto
Descalcificación
Descalcificação

Decalcificazione
Αφαιλάτωση
Odvápnění
Odkamienianie
Decalcarizare

устка от накипи
Kireçten arındırma
除垢
デスケール
스케일 청소

15



Installation
Installation
Installation
Installeren
Installation

Installasjon
Installation
Asennus
Instalar
Instalação

Installazione
Εγκατάσταση
Instalace
Instalacja
Operare

Установка
Yerleştirme
内容目録
目次
목차

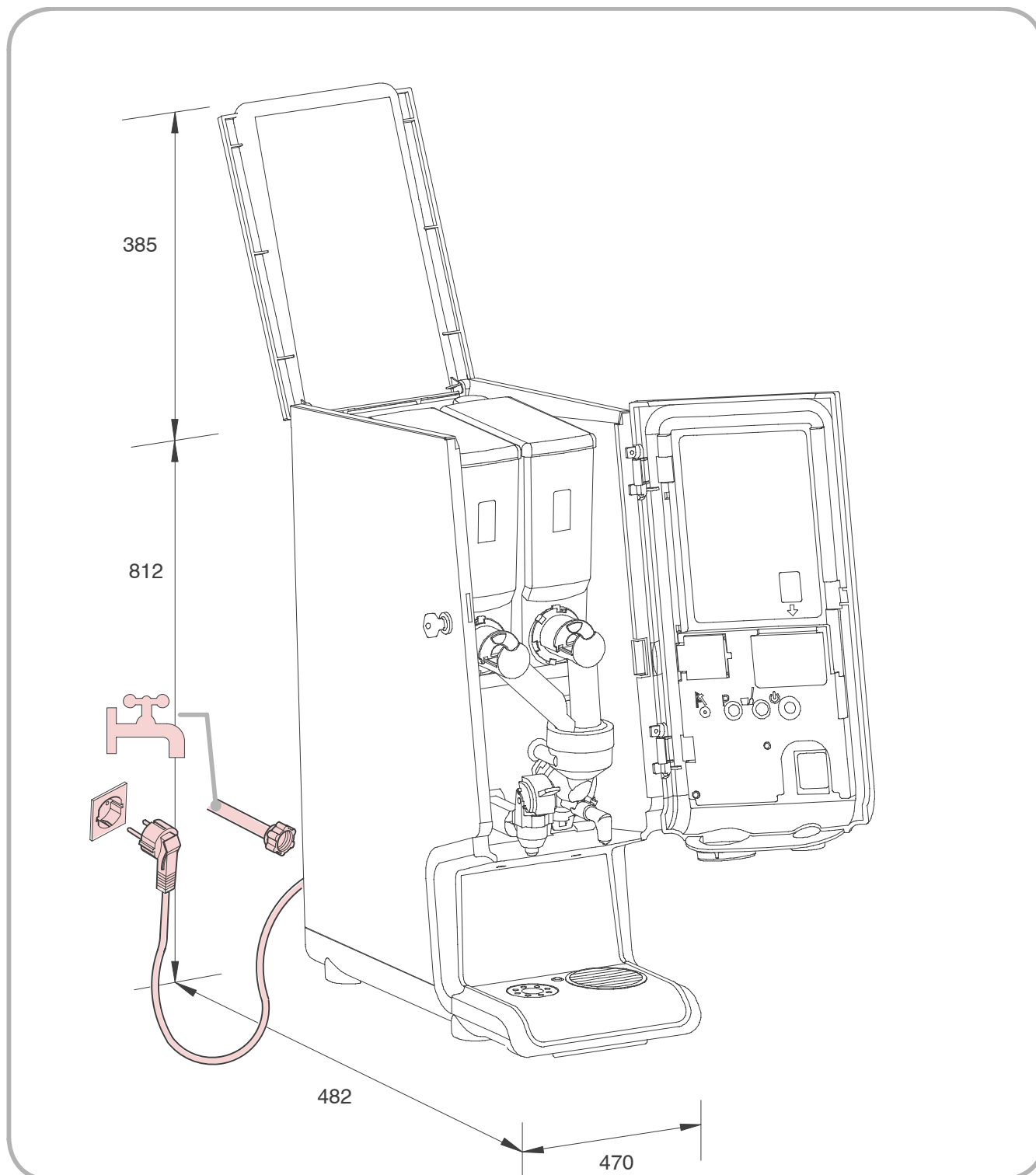



1.



70Q.403.347



2.



70Q.403.347

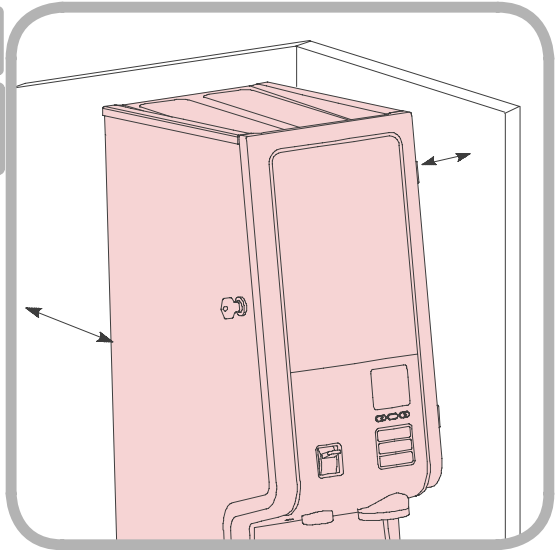

3.



70Q.403.347

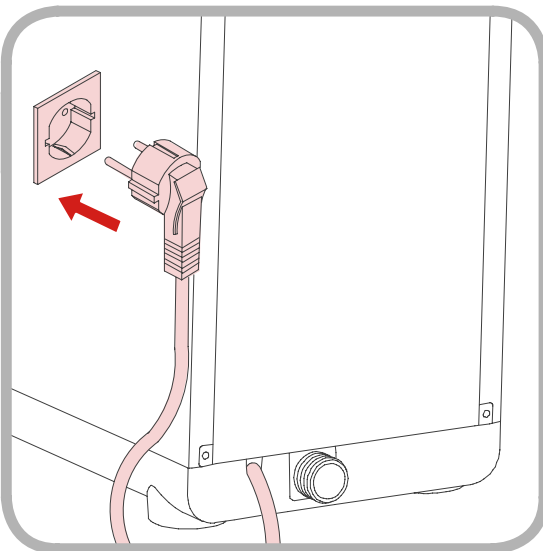

4.



70Q.403.347

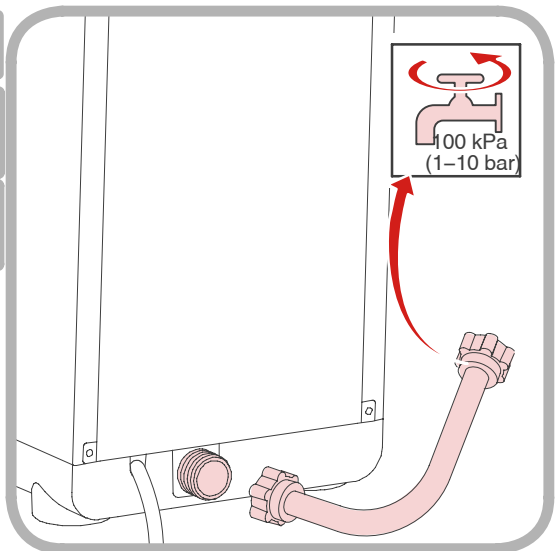

5.

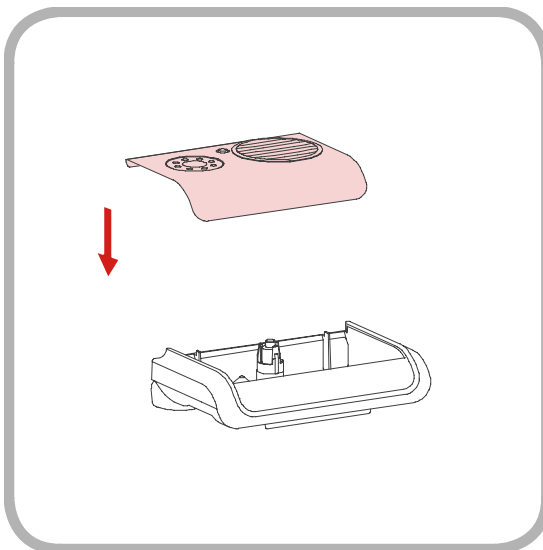

6.

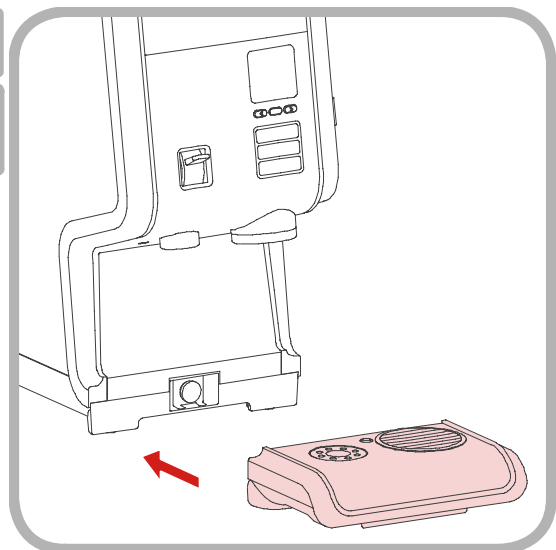



7.

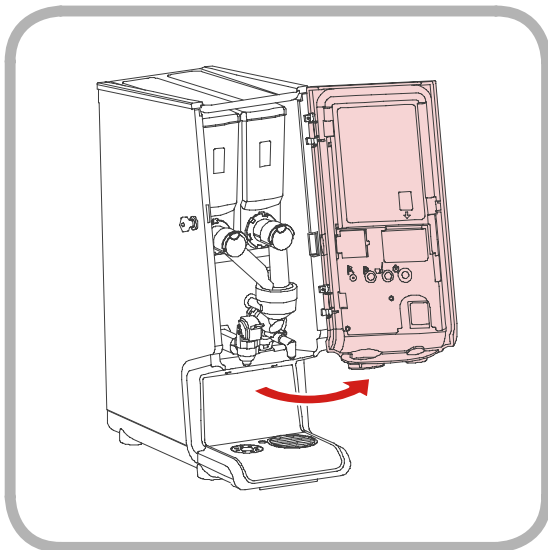

8.

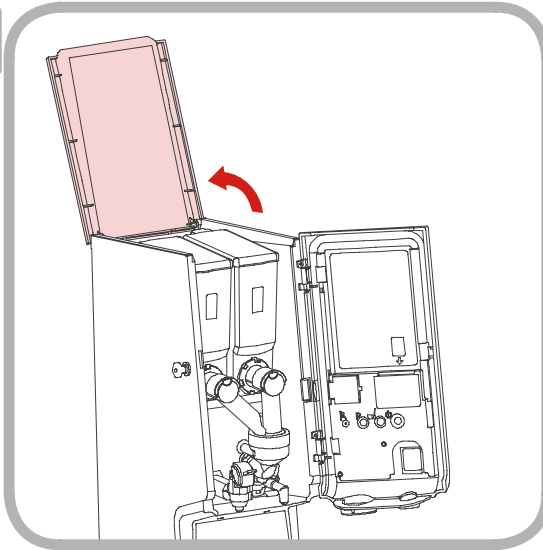

9.

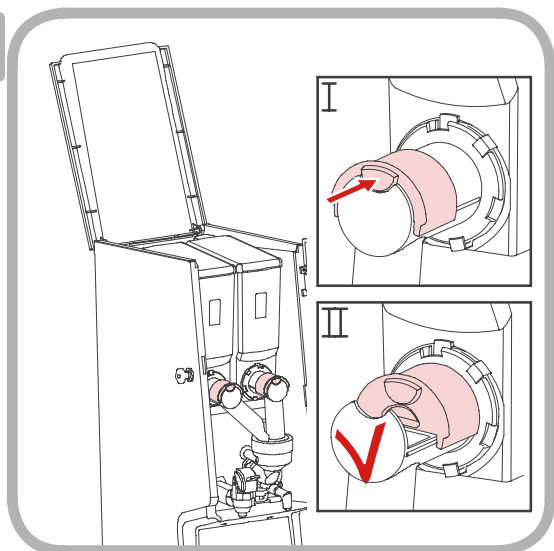

10.

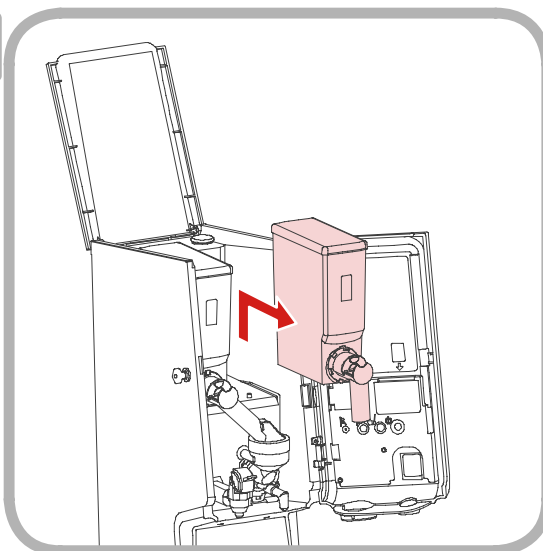

11.

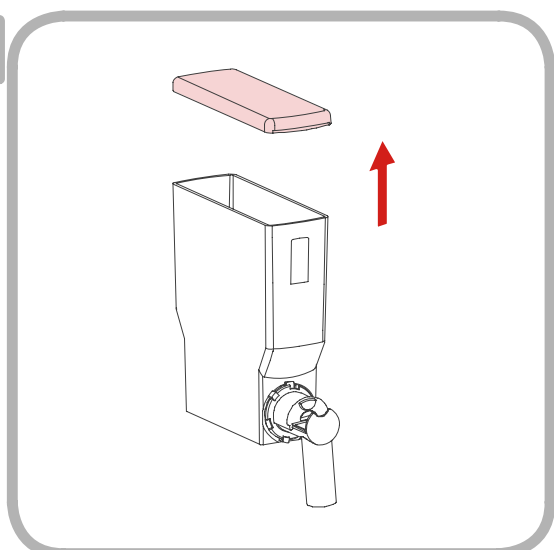

12.

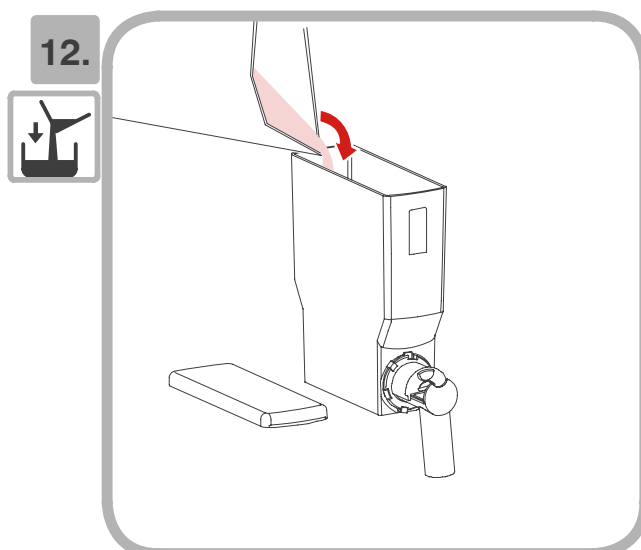



13.

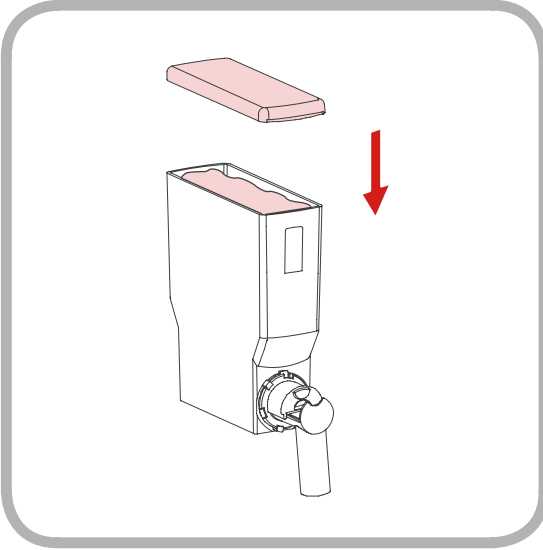

14.

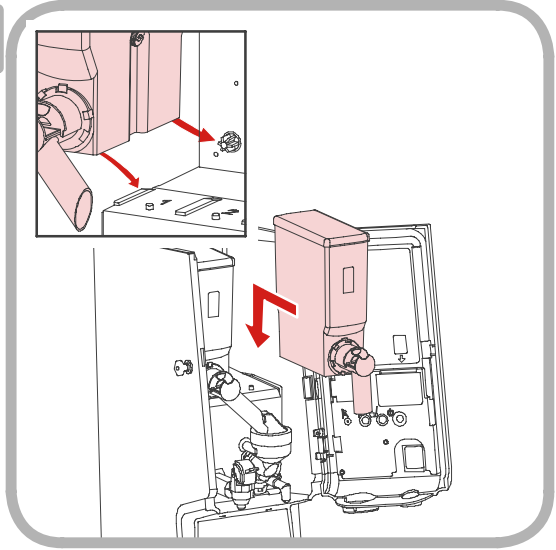

15.

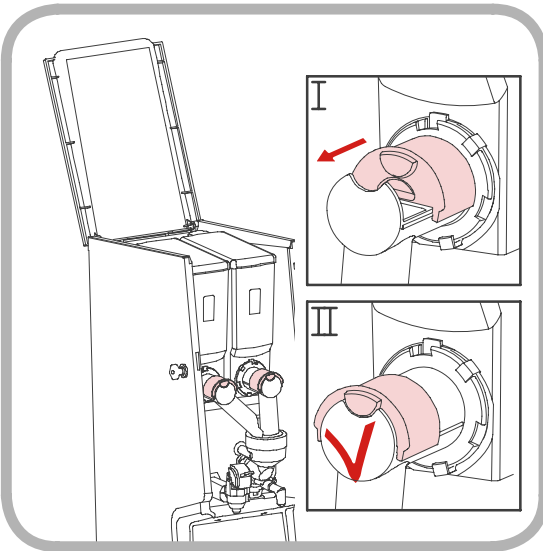

16.

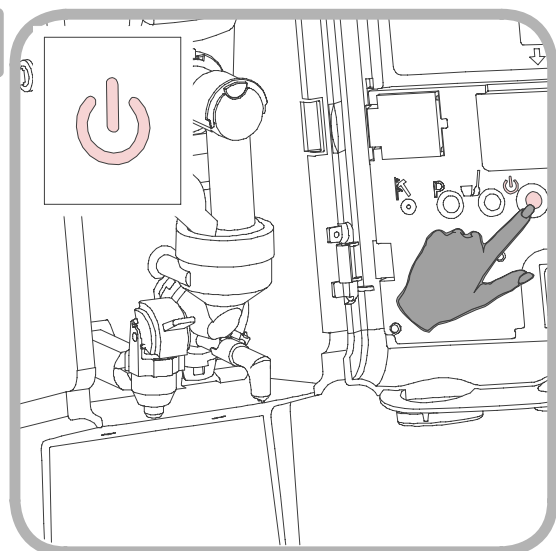

17.

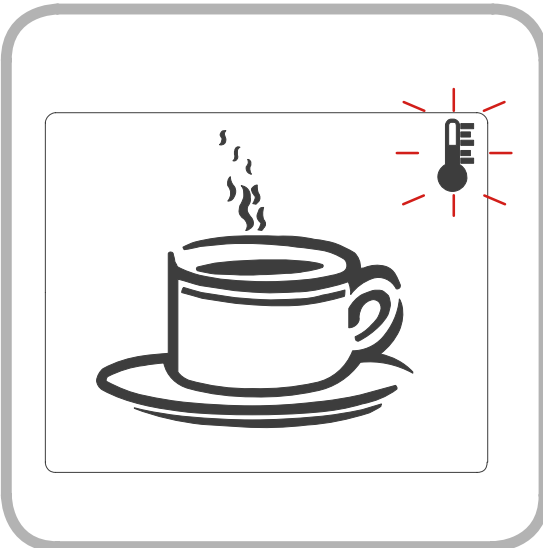

18.





19.

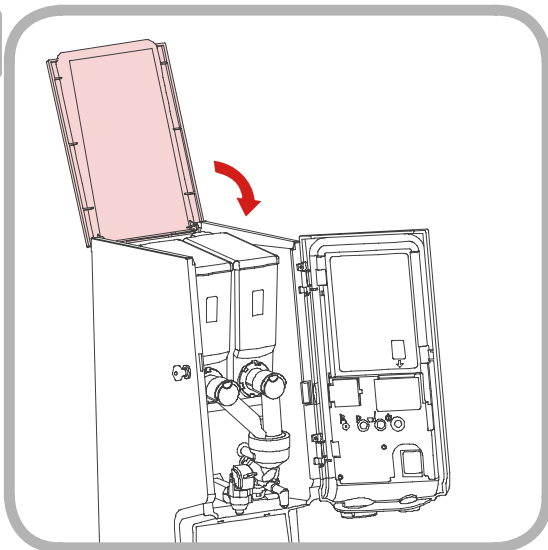

20.

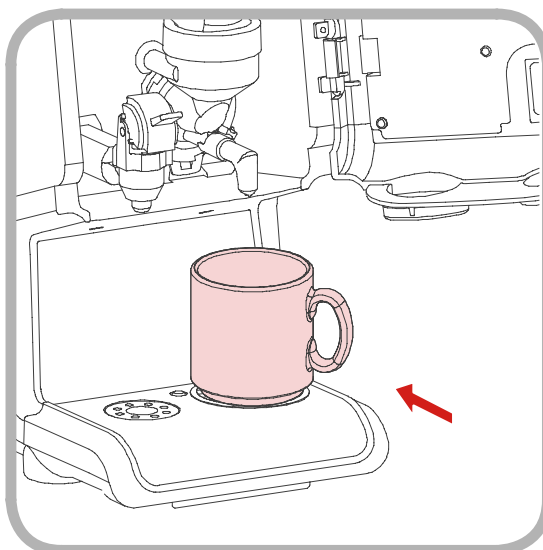

21.

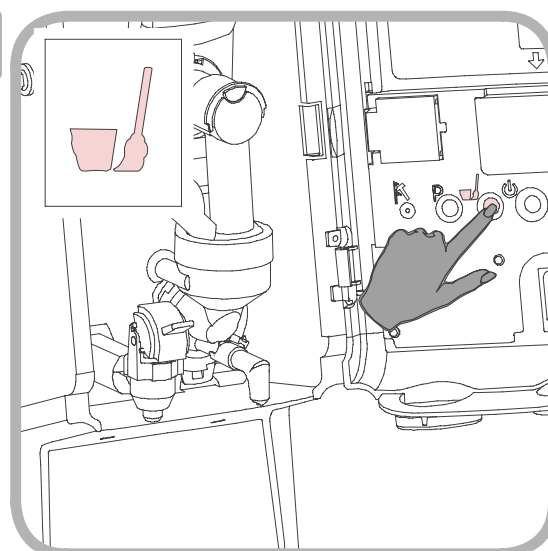

22.

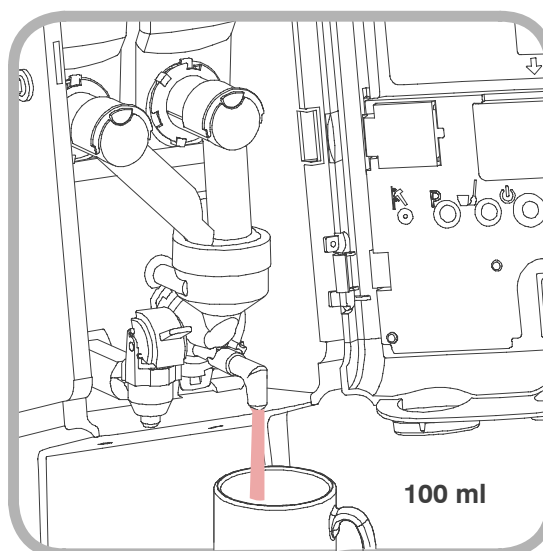

23.

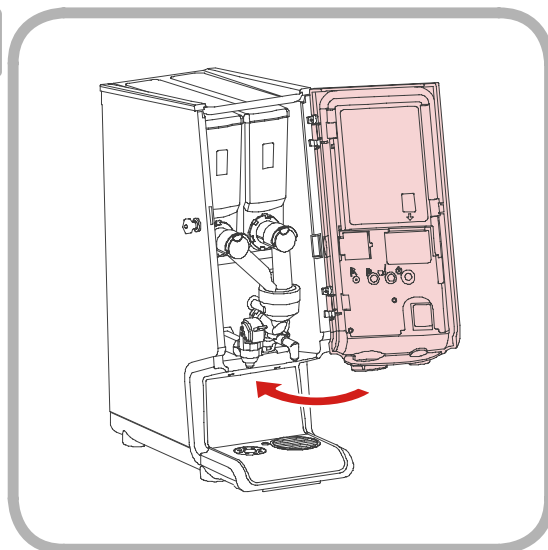

Programming
Programmation
Programmieren
Programmeren
Programmering

Programmering
Programmering
Ohjelmointi
Programar
Programação

Programmazione
Προγραμματισμός
λειτουργίας
Programování
Programowanie
Programare

Программирование
Programlama
程式
プログラミング
프로그램

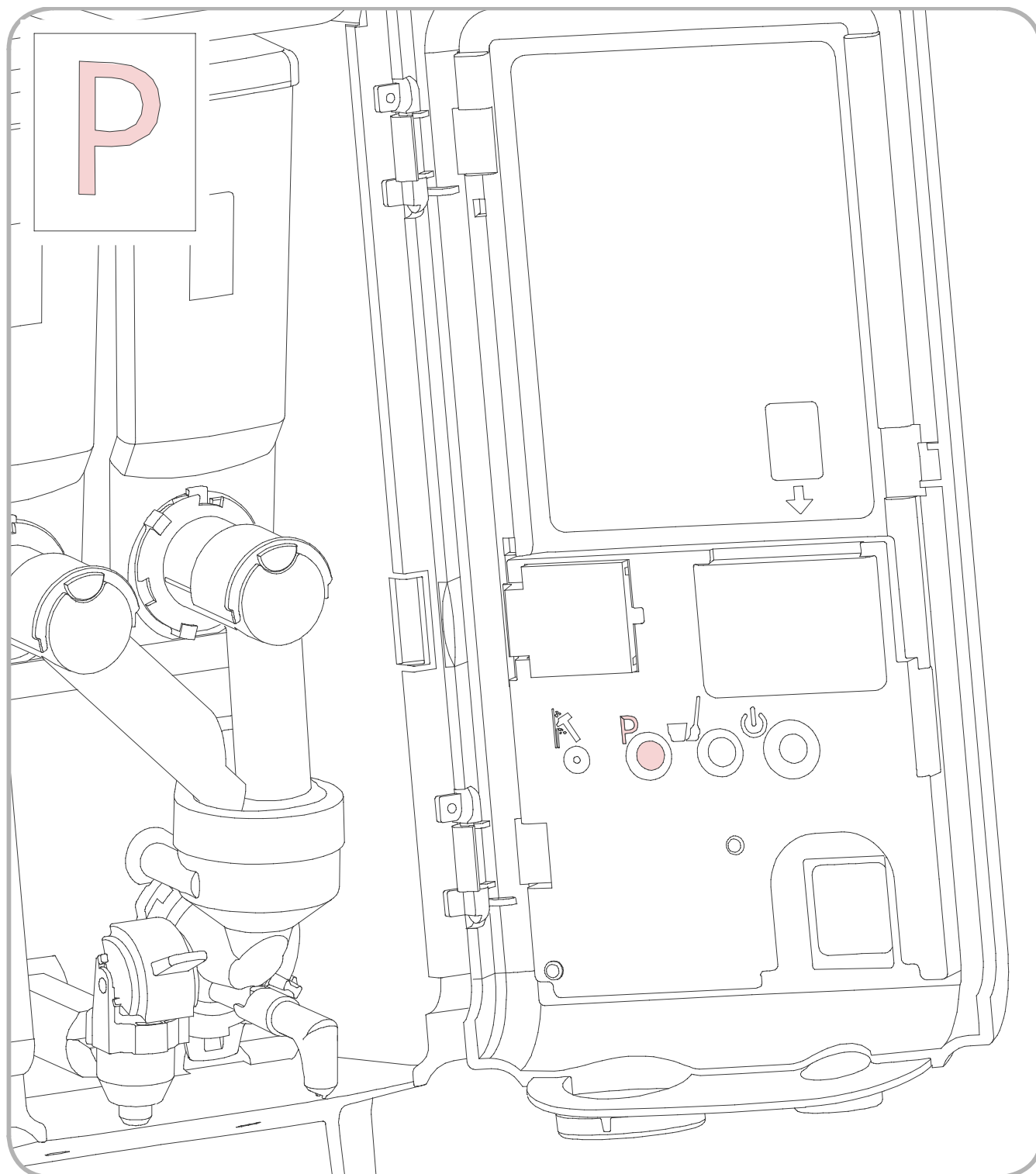

P

	☒	□	▲	■	←
English Français Deutsch Nederlands Svenska Norsk Dansk Suomi Español Português Italiano Ελληνικά Česky Polski Română Русский Türkçe 中文 日本語 한글	Off Eteint Aus Uit Av Slukket Pois päältä Apagado Desligado Spento Εκτός λειτουργίας Vyrnutí Wyłączone Oprit Выключено Kapalı 關閉 オフ 끄 짐	Minimum value Valeur minimum Minimum Wert Minimum waarde Minimum värde Minimum verdi Minimum værdi Minimi arvo Valor mínimo Valor mínimo Valore minimo Ελάχιστη τιμή Minimální hodnota Minimalna wartość Valoare minimă Минимальный объем Minimum değer 最小價值 最小値 최소치	Standard value Valeur standard Standard Wert Standaard waarde Standard värde Standard verdi Standard værdi Oletusarvo Valor estándar Valor standard Valore standart Θυσιολογική τιμή Standardní hodnota Standardowa wartość Valoare standard Стандартный объем Standart değer 標準價值 標準値 표준치	Maximum value Valeur maximum Maximum Wert maximum waarde Maximalt värde Maksimum verdi Maksimum værdi Maksimi arvo Valor máximo Valor máximo Valore massimo Μύγιστη τιμή Maximální hodnota Maksymalna wartość Valoare maximă Максимальный объем Maksimum değer 最大價值 最大値 최대치	Next step / confirm Etape suivante / confirmer Nächster Schritt / sichern Volgende stap / bevestigen Nästa steg / Bekräfta Neste steg / Bekreft Næste trin / Bekræft Seuraava / Vahvista Próximo nivel / confirmar Próximo passo / confirme Prossimo / passo Επόμενο βήμα / επιβεβαίωση Další krok / potvrdit Następny krok / potwierdzenie Pasul următor / confirma Следующий шаг / Подтвердить Sonraki adım / Onayla 下一步/確認 次のステップ 다음단계/확인

1.

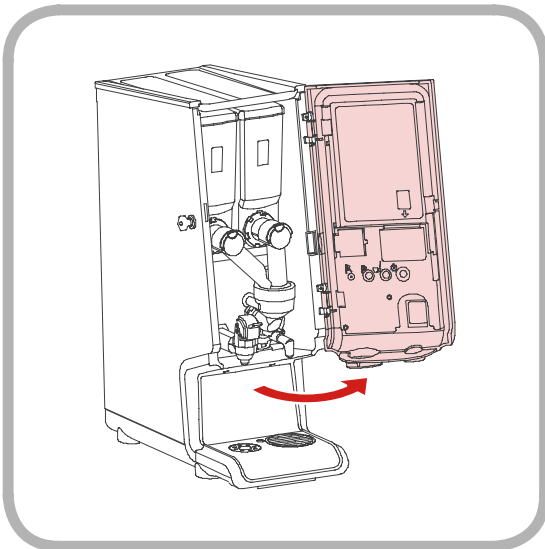

2.

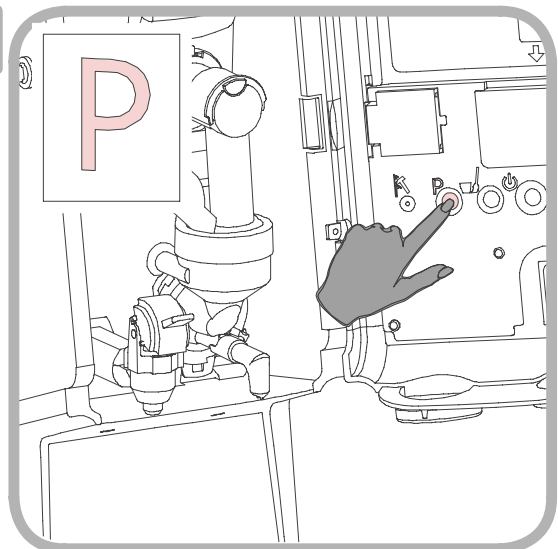

3.

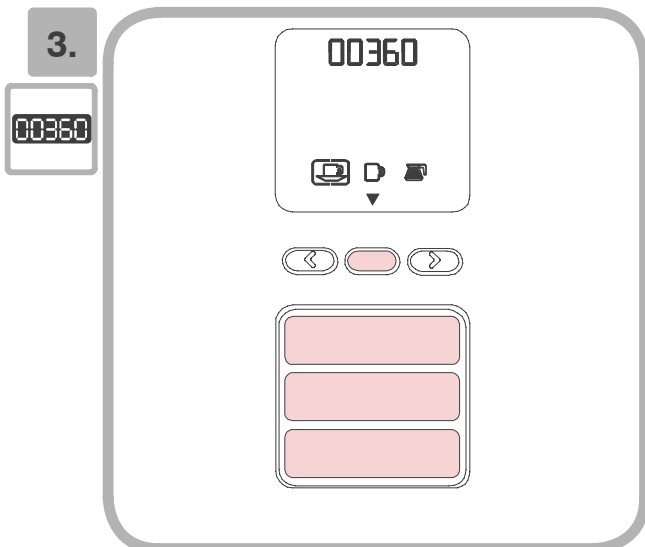

4.

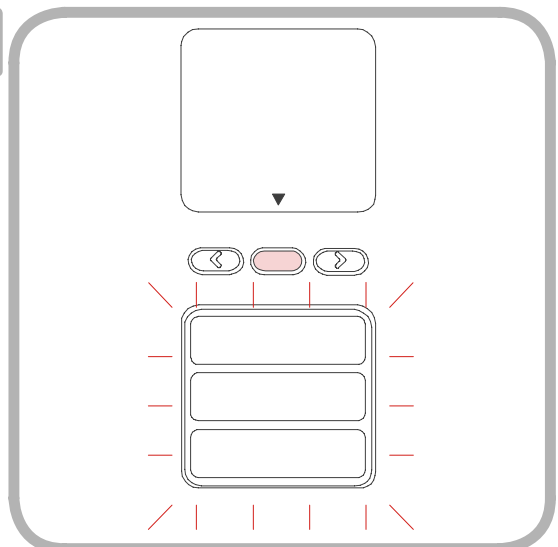

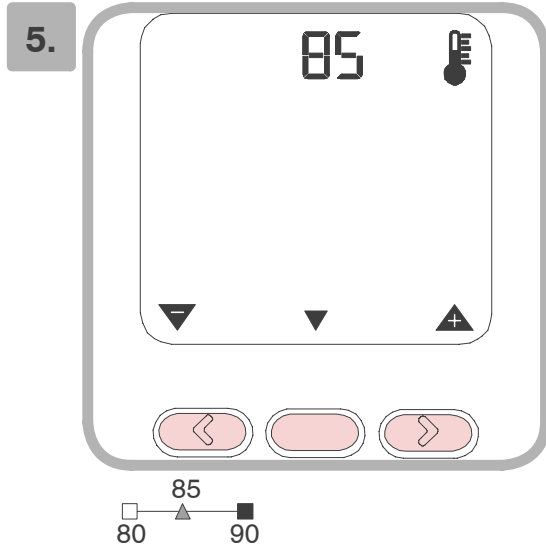

Boiler temperature
Température chaudière
Boiler Temperatur
Boiler temperatuur
Temperatur kokare
Elementtemperatur
Vand temperatur
Säiliön lämpötila
Temperatura de la resistencia
Temperatura da caldeira
Temperatura boiler
Θερμοκρασία λέβητα
Teplota boileru
Temperatura bojlera
Temperaturä boiler
Температура в бойлере
Boiler derecesi
熱水器溫度
ボイラー温度
보일러 온도

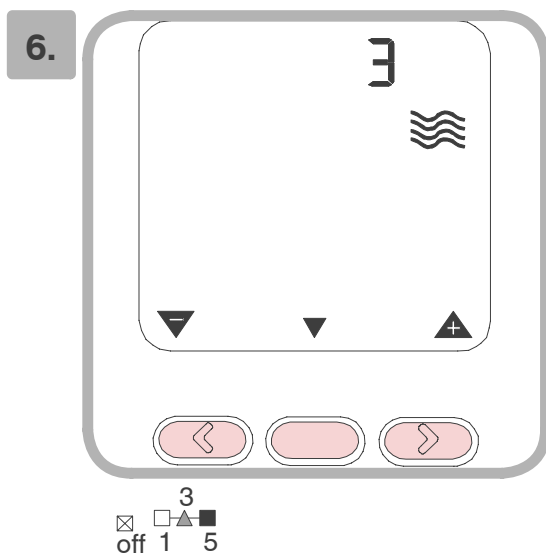

Descaling signal
Signalisation d'entartrage
Entkalkungsanzeige
Ontkalkingsignalering
Avkalkningssignal
Rensesignal
Afkalknings signal
Kalkinpoistomerkki
Señalización de descalcificación
Sinal de descalcificação
Identificazione della decalcificazione
Ένδειξη αφαλάτωσης
Signal odvárnění
Sygnał akustyczny odkamieniania
Semnal decalcarizare
Сигнал для Ристки от накипи
Kireçten arındırma sinyali
除垢訊號
デスケール表示
스케일 청소 표시

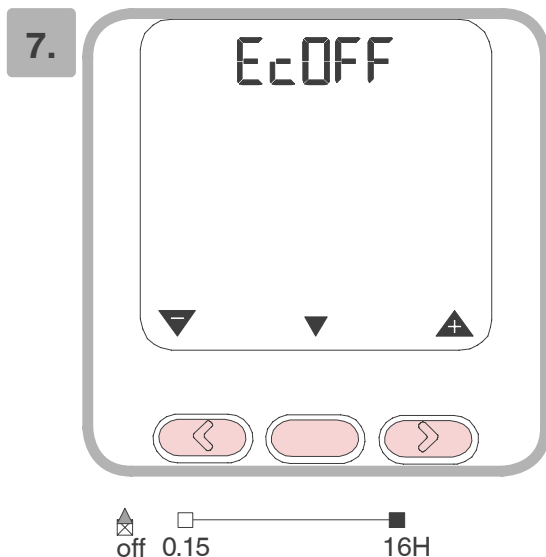

Energy-saving mode
Mode économique
Energiesparstufe
Energie spaarstand
Energisparläge
Energisparingsmodus
Energi spare funktion
Sähköä säästävä malli
Posición de economía
Economizador de energia
Risparmio energia
Ένδειξη εξοικονόμησης ενέργειας
Ochrona energie
Tryb pracy "eco" oszczędzający energię
Mod economic
Экономичный режим
Enerji tasarrufu modu
能源節省模式
省エネモード
에너지 절약형 모드

P

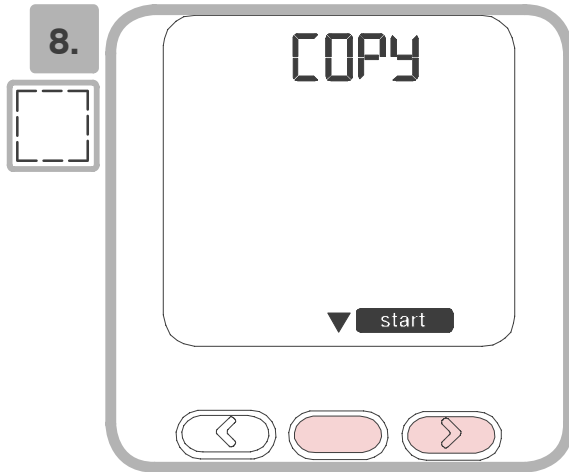

Copy customer-specific adjustments (Chipcard)
Copier les paramètres spécifiques du client (Carte à mémoire)
Kundenspezifische Einstellung kopieren (Chipkarte)
Klantspecifieke instellingen kopiëren (Chipkaart)
Kopiera kundspecifika inställningar (Chipcard)
Kopier kundetilpassede innstillinger (Chipcard)
Kopier kundespecifikke innstillinger (Chipkort)
Kopioi asiakaskohtaiset asetukset (Muistikortti)
Copiar programación específica del cliente (Chipcard)
Cópia programação específico de cliente (Chipcard)
Copiare i parametri specifici del cliente (carte cip)
Αντιγραφή ειδικών παραμετρώσεων πελάτη (Κάρτα μνήμης)
Zákaznická kopie specifické nastavení (Čipová karta)
Kopiować ustawienie specyficzne klienta (Karta chipowa)
Копирование данных на специальное устройство клиента (Чип)
Copiati parametri specifici ai clientului (Card memorie)
顧客拷貝 - 特定調較 (晶片)
顧客特殊設定をコピーしてください。(チップカード)
복사 고객- 사양 조정 (칩 카드)

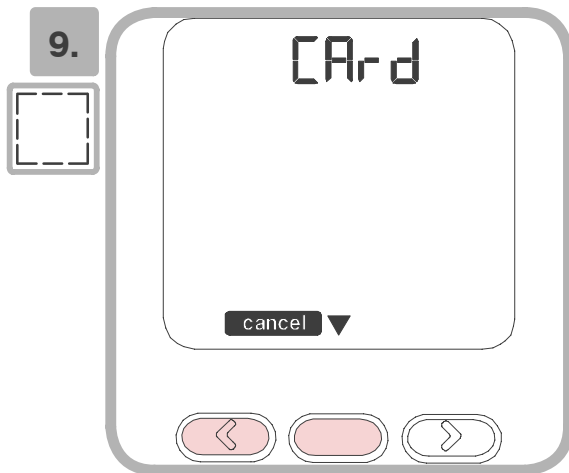

10.

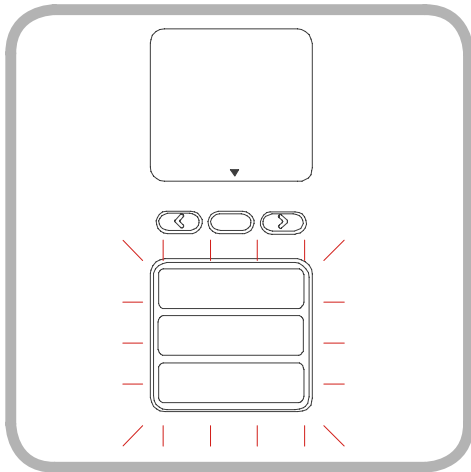

11.

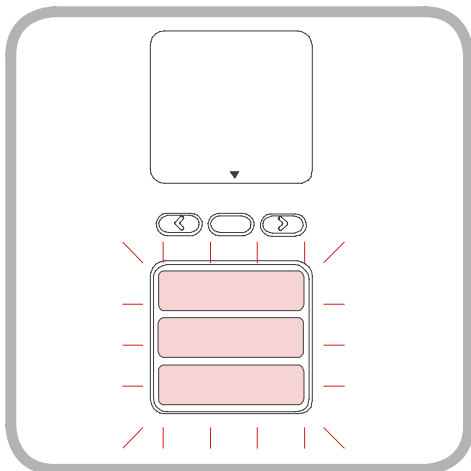

12.

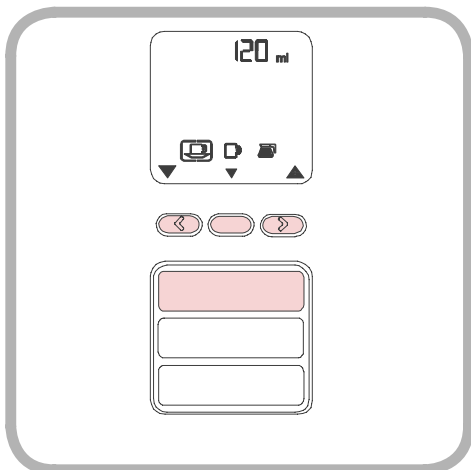

☒ ☐ ————— ■
off 20 720

Programming (drink dependent)
 Programmation (selon boisson)
 Programmieren (Getränke abhängig)
 Programmeren (drank afhankelijk)
 Programmering (färdig dryck)
 Programmering (drikkeavhengig)
 Programmering (afhængig af drik)
 Ohjelmointi (juomakohtainen)
 Programar (dependiendo a la bebida)
 Programação (bebida dependente)
 Programmazione (dipendendo bevando)
 Προγραμματισμός λειτουργίας (αναλόγως ποτού)
 Programování (závisí na nápoji)
 Programowanie (w zależności od rodzaju napoju)
 Programar (dependentă de băutură)
 Программирование (выбранного напитка)
 Programlama (İçeceğe bağlı)
 程式 (按飲品)
 プログラミング (種類別に設定)
 프로그램 (음료의 종류에 따라 다름)

Amount per cup (drink dependent)
 Quantité par tasse (selon boisson)
 Füllmenge Tasse (Getränke abhängig)
 Doseergrootte kop (drank afhankelijk)
 Kvantitet/kopp (färdig dryck)
 Mengde pr. kopp (drikkeavhengig)
 Mængde pr. kop (afhængig af drik)
 Määrä / kuppi (juomakohtainen)
 Dos. grandezza de taza (dependiendo a la bebida)
 Quantidade por chávena (bebida dependente)
 Dosaggio per tazza (dipendendo bevando)
 Ποσότητα ανά φλιτζάνι (αναλόγως ποτού)
 Množství na šálek (závisí na nápoji)
 Ilość na filiżankę (w zależności od rodzaju napoju)
 Cantitate per ceașcă (dependentă de băutură)
 Доза выбранного напитка на Рашку
 Bir fincan için miktarı (İçeceğe bağlı)
 每小杯份量(按飲品)
 小カップ一杯当りの量 (種類別に設定)
 컵당 량(음료의 종류에 따라 다름)

13.

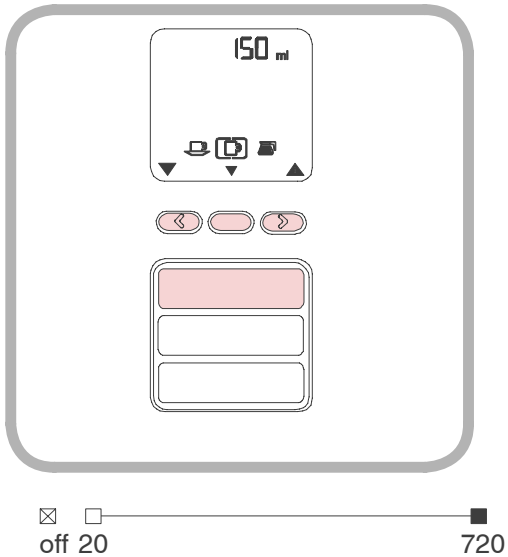

Amount per mug (drink dependent)
 Quantité par grande tasse (selon boisson)
 Füllmenge Becher (Getränk abhängig)
 Doseergrootte beker (drank afhankelijk)
 Kvantitet/mugg (färdig dryck)
 Mengde pr. krus (drikkeavhengig)
 Mængde pr. krus (afhængig af drik)
 Määrä / muki (juomakohtainen)
 Dos. grandeza de tazón (dependiendo a la bebida)
 Quantidade por caneca (bebida dependente)
 Dosaggio tazza grande (dipendendo bevando)
 Ποσότητα ανά κούπα (ανάλογως ποτού)
 Množství na džbánek (závisí na nápoji)
 Ilość na kubek (w zależności od rodzaju napoju)
 Cantitate per cană (dependentă de băutură)
 Доза выбранного напитка на кружку
 Bir maşgara için miktarı (İçeceği bağıli)
 每大杯份量(按飲品)
 大カップ一杯当りの量 (種類別に設定)
 머그컵당 량(음료의 종류에 따라 다름)

14.

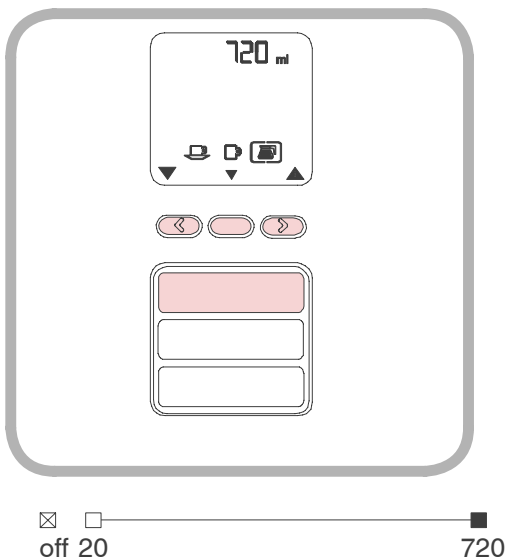

Amount per decanter (drink dependent)
 Quantité par pichet (selon boisson)
 Füllmenge Kanne (Getränk abhängig)
 Doseergrootte kan (drank afhankelijk)
 Kvantitet/kanna (färdig dryck)
 Mengde pr. kanne (drikkeavhengig)
 Mængde pr. kande (afhængig af drik)
 Määrä / kannu (juomakohtainen)
 Dos. grandeza de jarra (dependiendo a la bebida)
 Quantidade por jarro (bebida dependente)
 Dosaggio per Bricco (dipendendo bevando)
 Ποσότητα ανά κανάτα (ανάλογως ποτού)
 Množství na konvici (závisí na nápoji)
 Ilość na dzbanek (w zależności od rodzaju napoju)
 Cantitate per bol (dependentă de băutură)
 Доза выбранного напитка на графин
 Bir pot için miktarı (İçeceği bağıli)
 每壺份量(按飲品)
 デカンター一杯当りの量 (種類別に設定)
 디켄터당 량(음료의 종류에 따라 다름)

15.

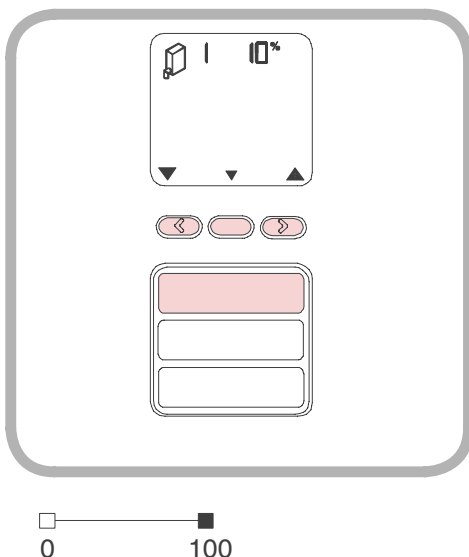

Basic strength (drink dependent)
 Réglage goût de base (selon boisson)
 Basis Stärke (Getränk abhängig)
 Basis sterkte (drank afhankelijk)
 Normal styrka (färdig dryck)
 Grunnstyrke (drikkeavhengig)
 Standard styrke (afhængig af drik)
 Normaali vahvuus (juomakohtainen)
 Fuerza básica (dependiendo a la bebida)
 Dureza básica (bebida dependente)
 Gusto standart (dipendendo bevando)
 Βασική ισχύς (ανάλογως ποτού)
 Základní množství (závisí na nápoji)
 Podstawowa moc (w zależności od rodzaju napoju)
 Concentrație de bază (dependentă de băutură)
 Базовая насыщенность выбранного напитка
 Normal kuvvette (İçeceği bağıli)
 基本濃度(按飲品)
 標準濃度 (種類別に設定)
 기본농도(음료의 종류에 따라 다름)

16.

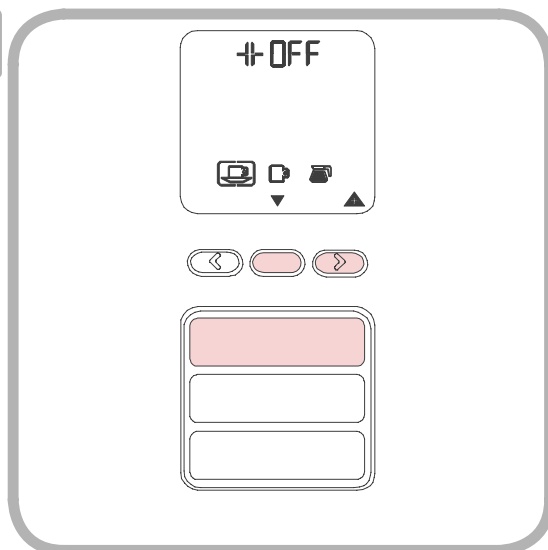

Mixer (on / off)
 Mixeur (marche / arrêt)
 Mixer (An / Aus)
 Mixer (aan / uit)
 Visp (på / av)
 Mikser (på / av)
 Mixer (tænd / sluk)
 Sekoittaja (päällä / pois päältä)
 Mezclador (encendido / apagado)
 Misturador (ligado / desligado)
 Frullatore (accesso / spento)
 Λειτουργία (ευτός / εκτός)
 Mísicí (zapnuta / vypnuta)
 Mieszanie (włączone / wyłączone)
 Mixer (pornit/oprit)
 Миксер (включено / выключено)
 Karistirici (açık / kapalı)
 攪拌器 (開/關)
 ミキサー (オン/オフ)
 믹서 (켜짐/ 꺼짐)

17.

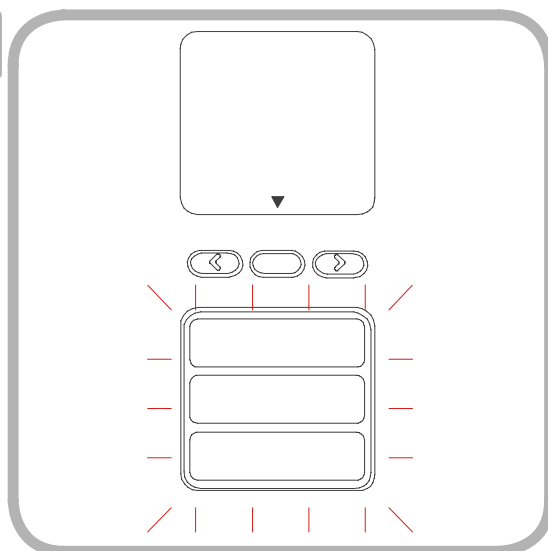

18.

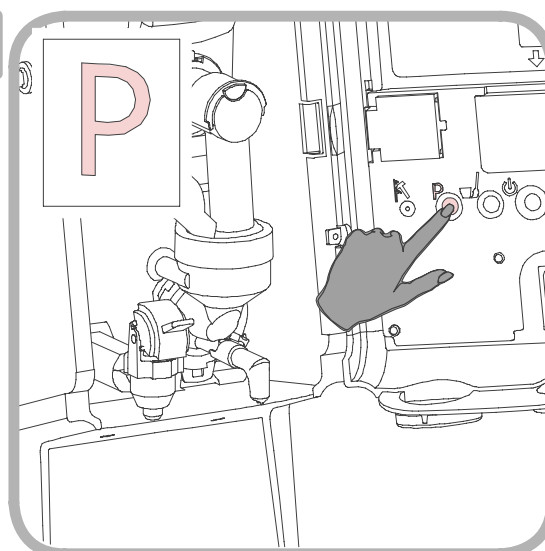

19.

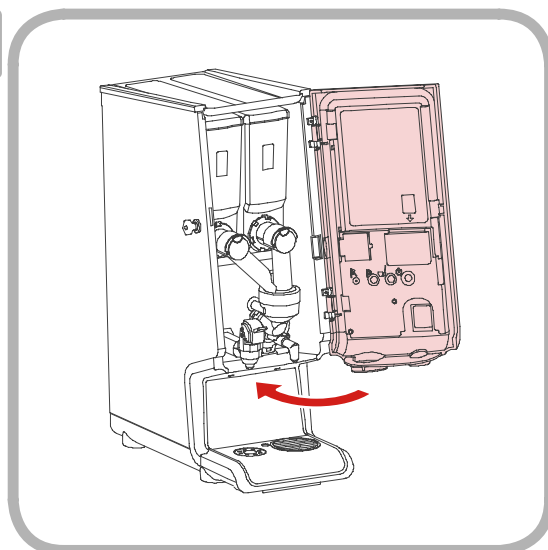



Descaling
Détartrage
Entkalkung
Ontkalken
Avkalkning

Rensing
Afkalkning
Kalkinpoisto
Descalcificación
Descalcificação

Decalcificazione
Αφαλάτωση
Odvápnění
Odkamienianie
Decalcarizare

уистка от накипи
Kireçten arındırma
除垢
デスケール
스케일 청소

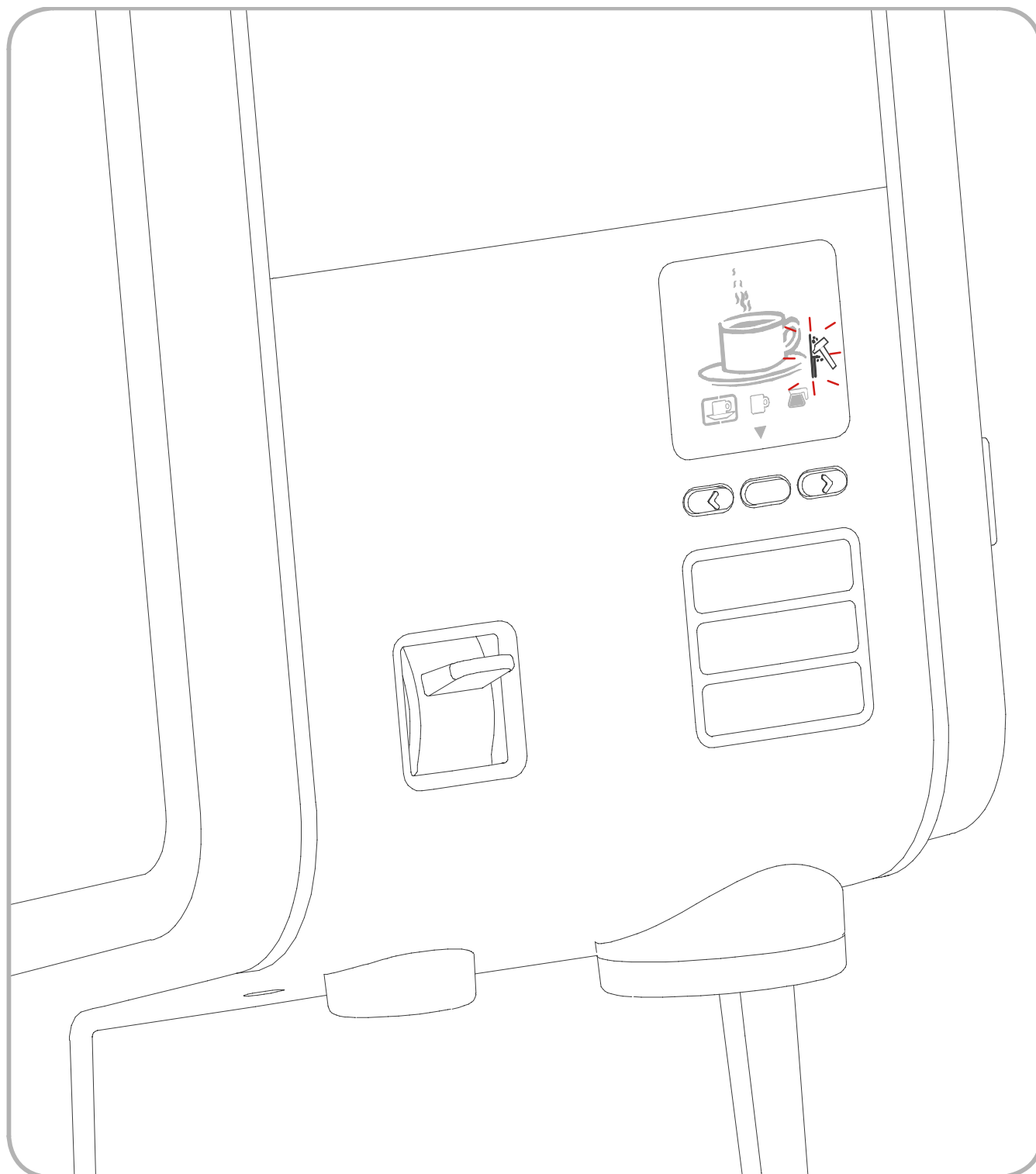



1.



2.

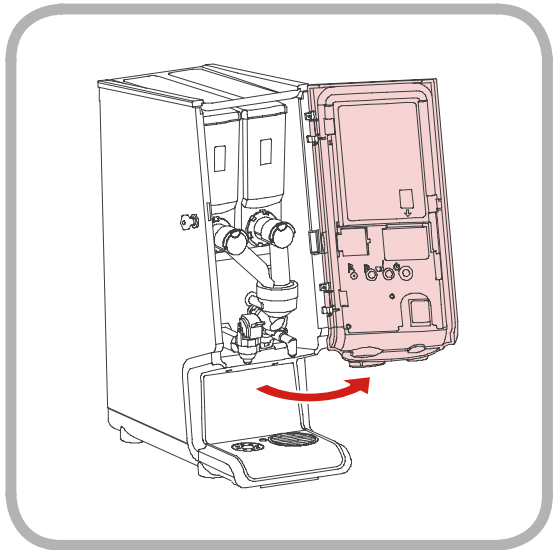

3.

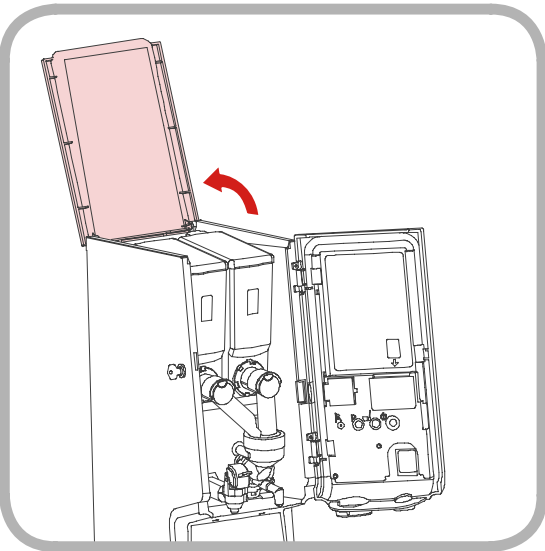

4.

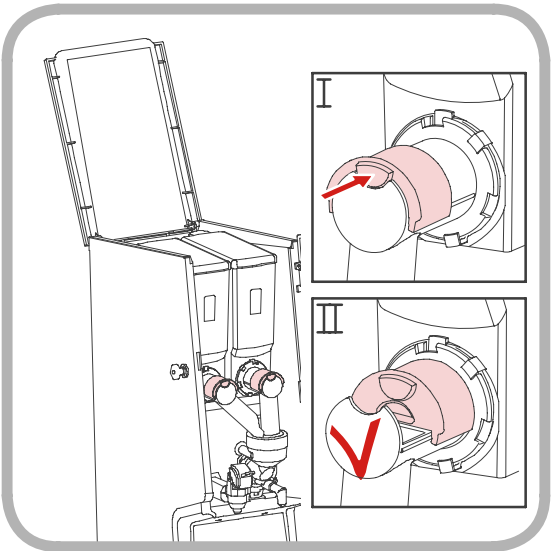

5.

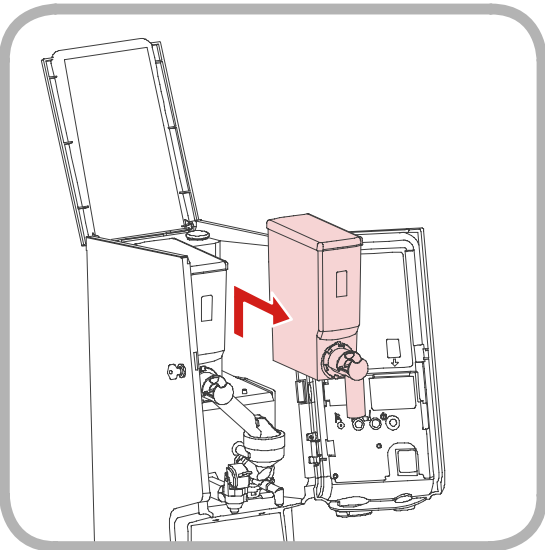

6.

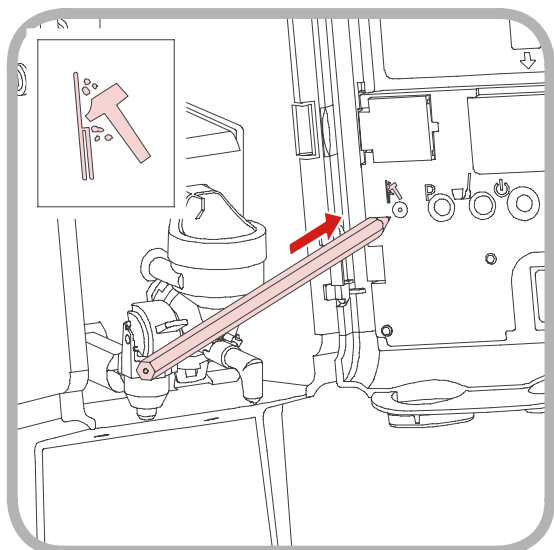

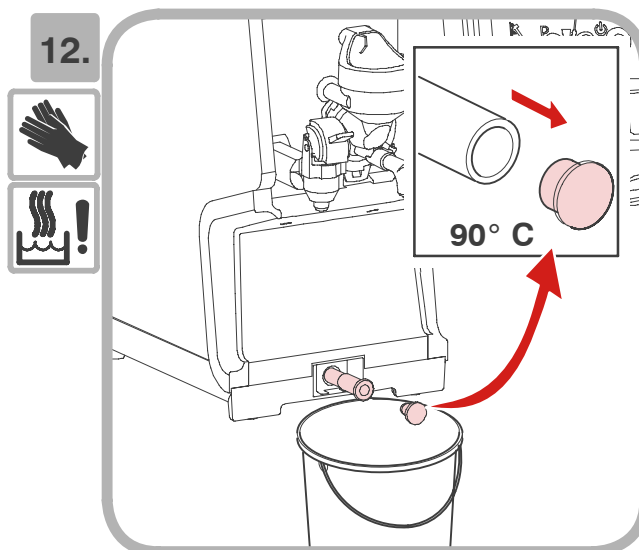
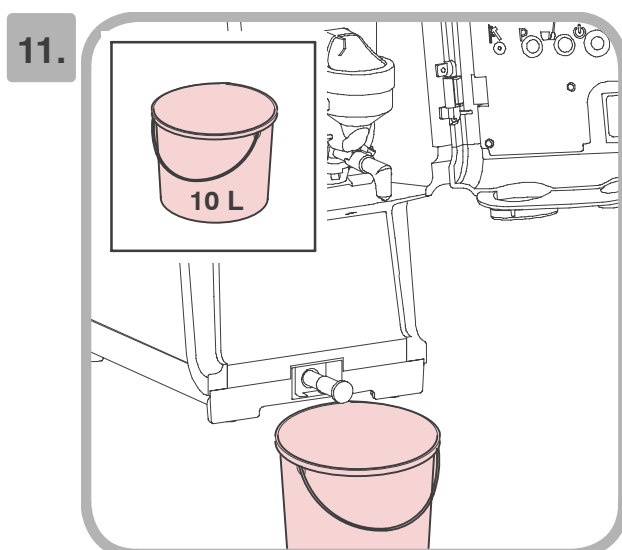
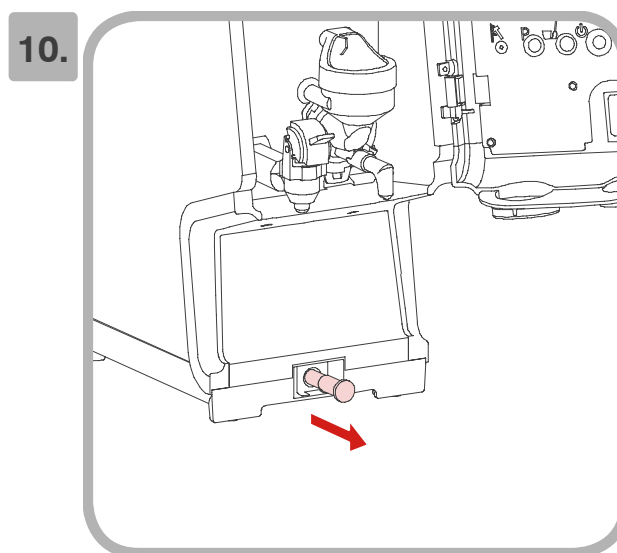
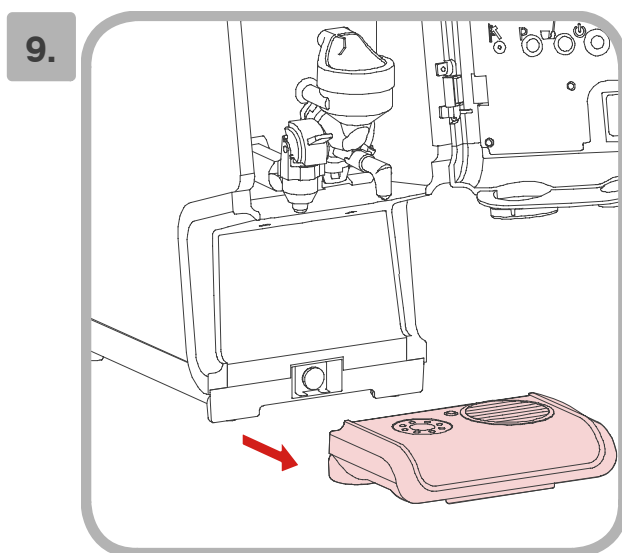
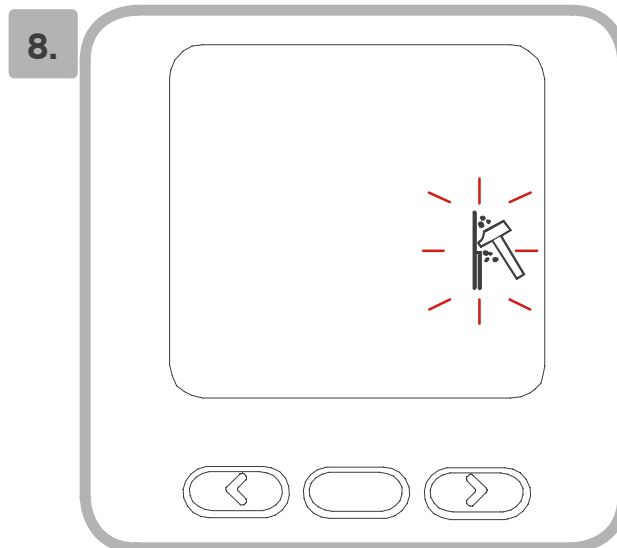
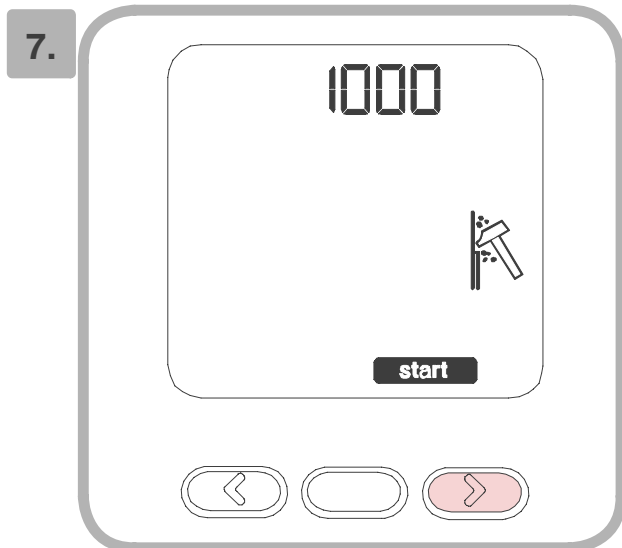



13.

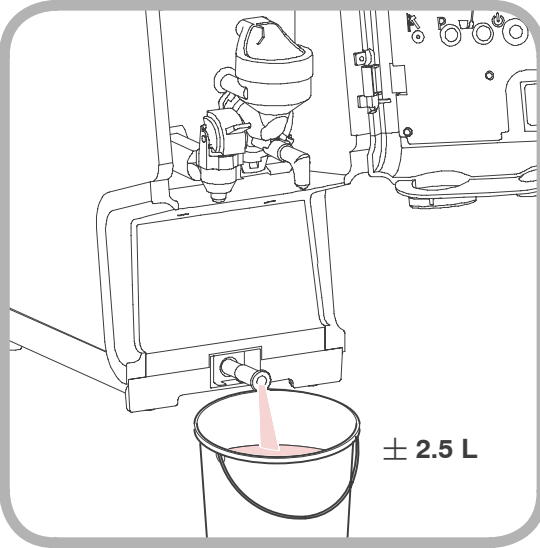

14.

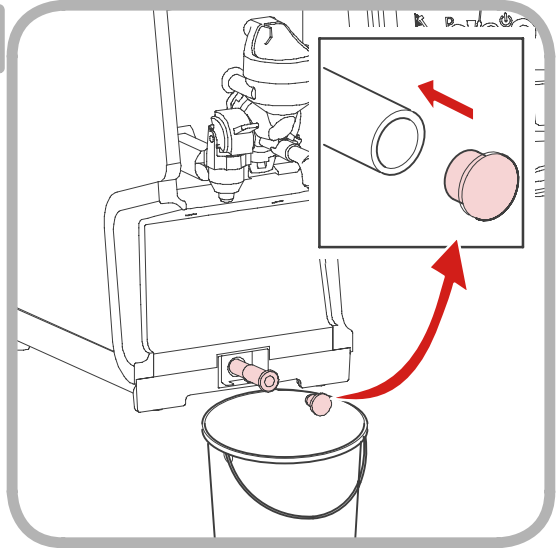

15.



700.403.347

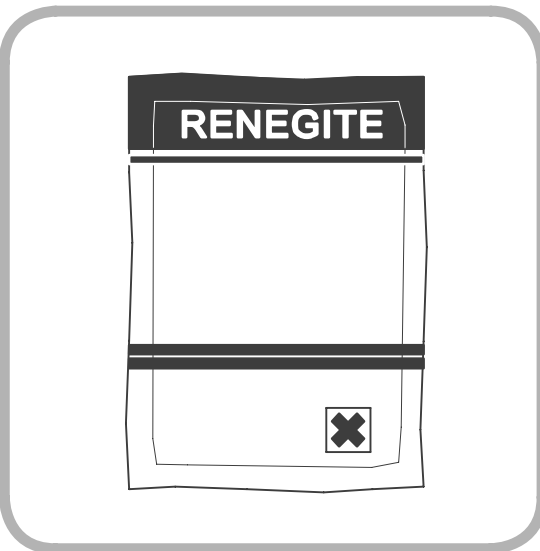

16.

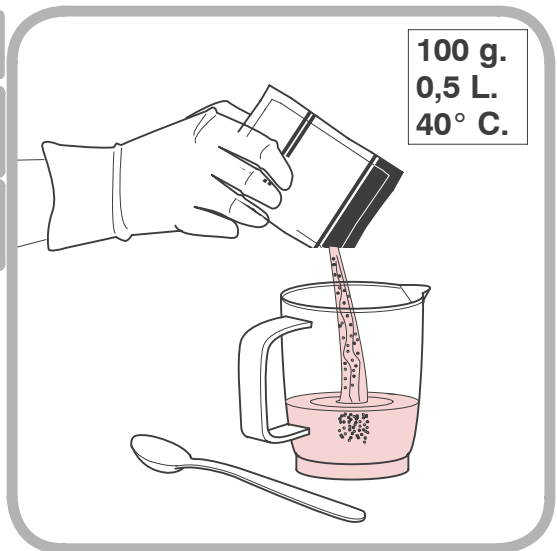

17.

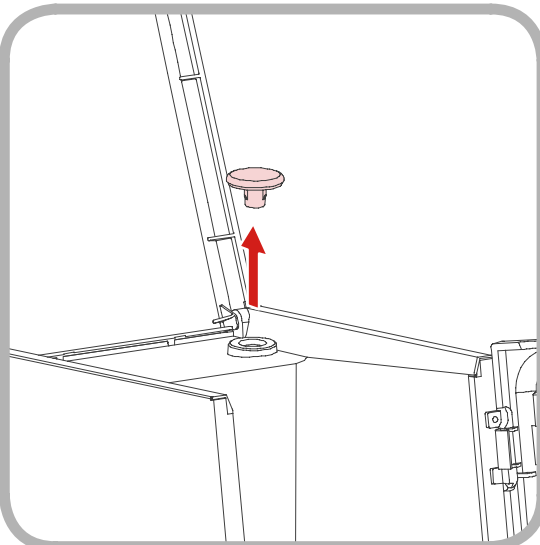

18.

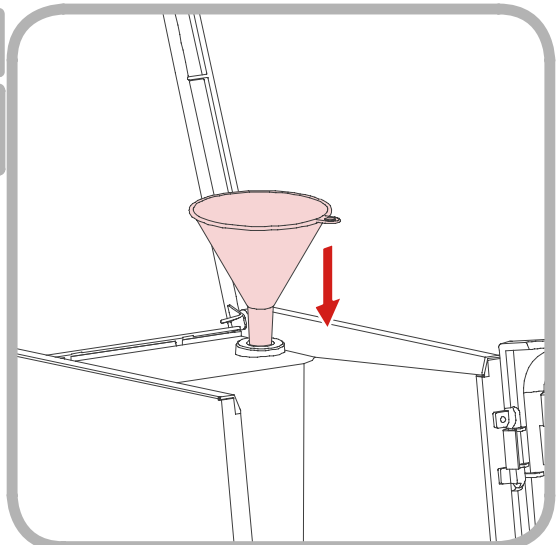

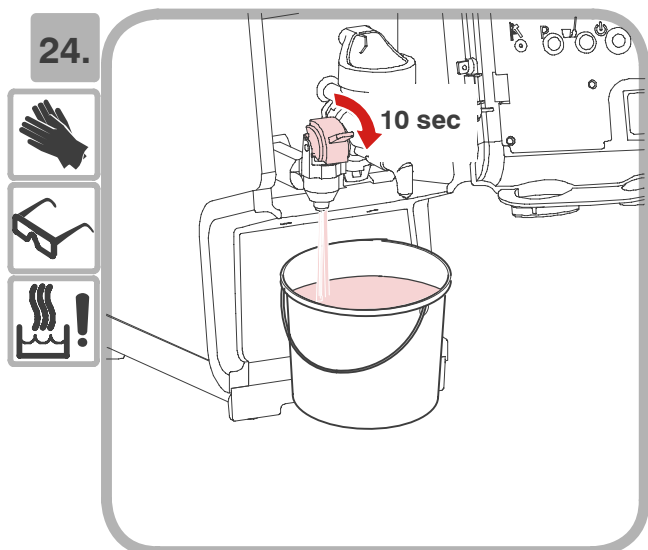
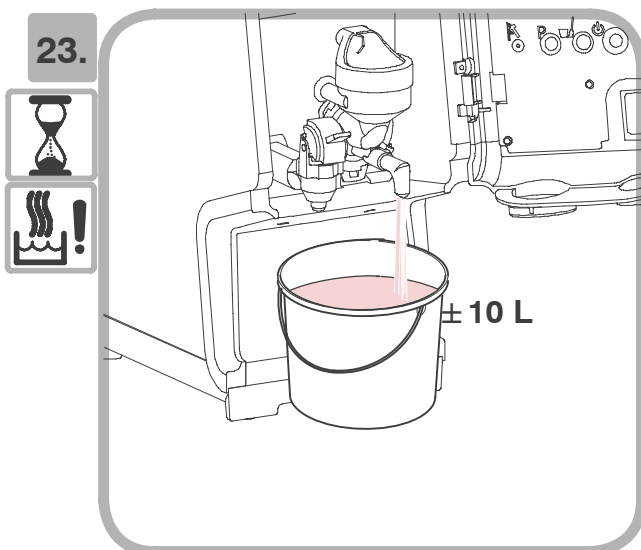
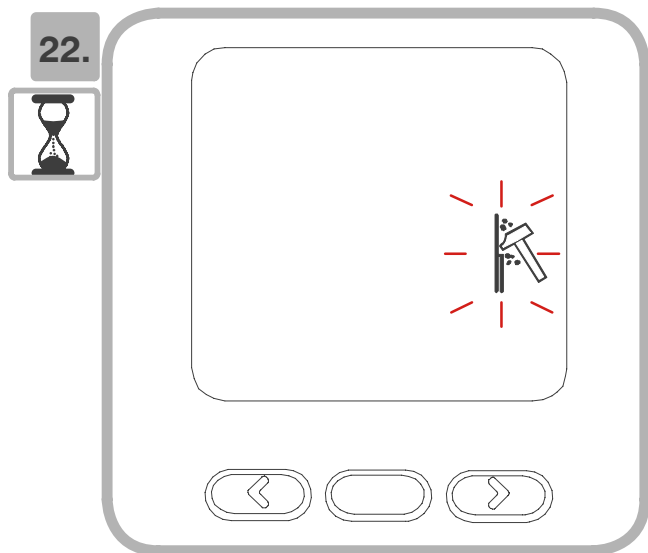
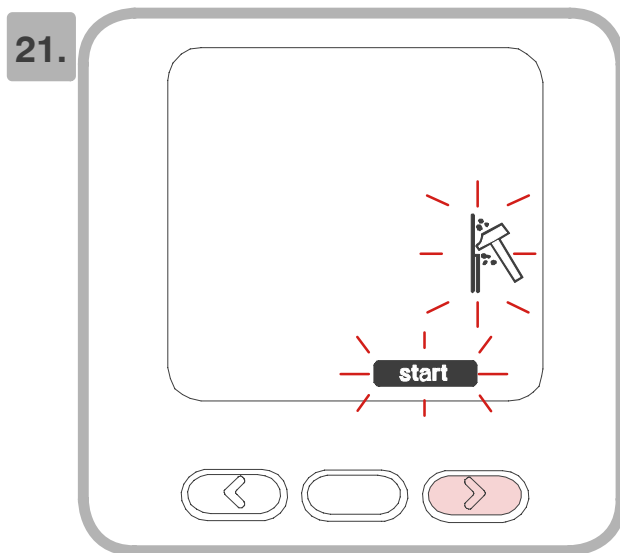
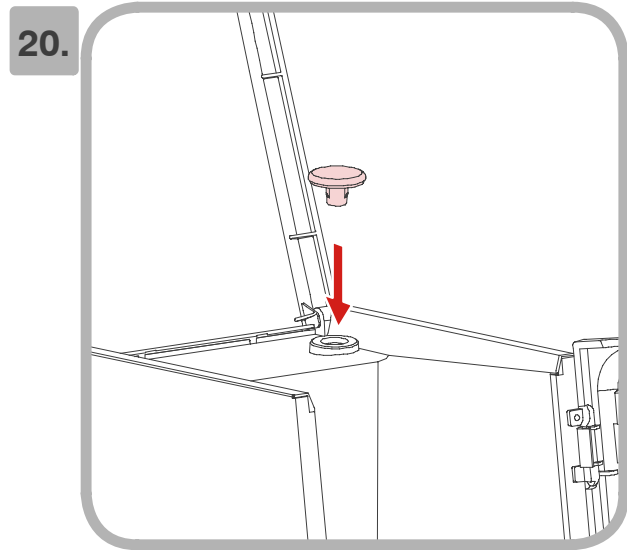
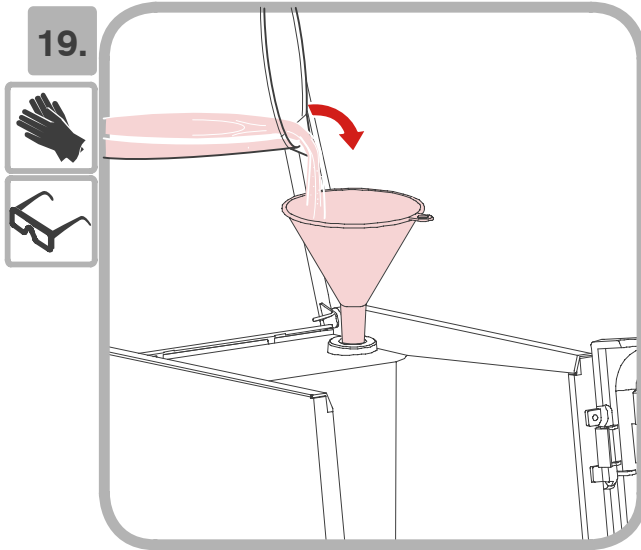



25.

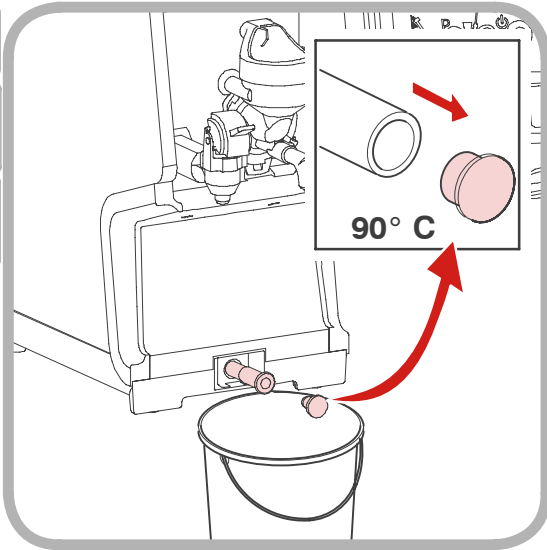

26.

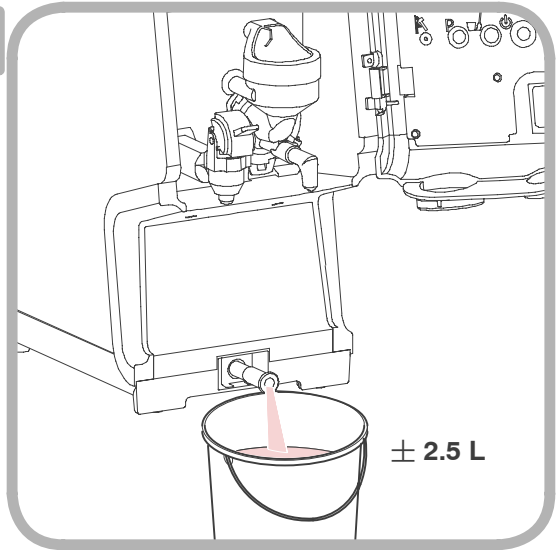

27.

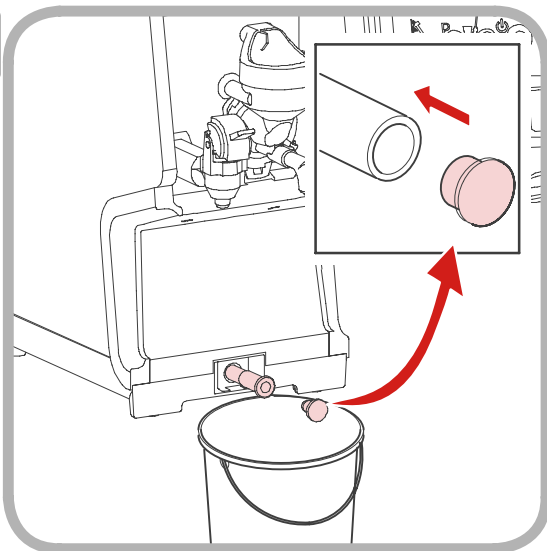

28.

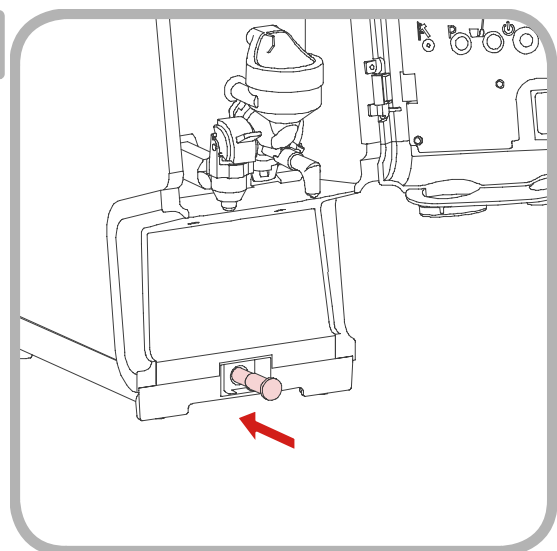

29.

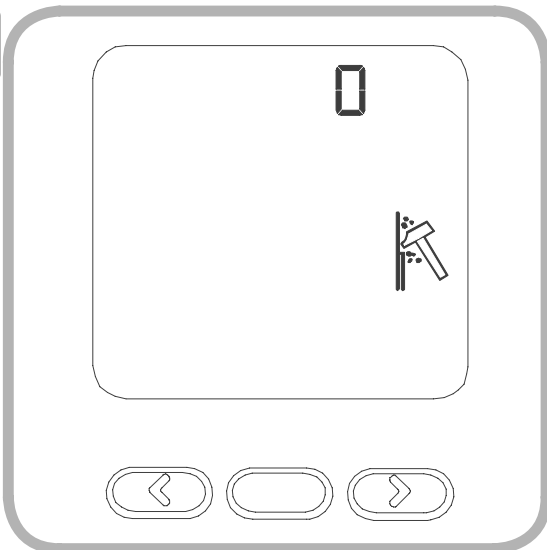

30.

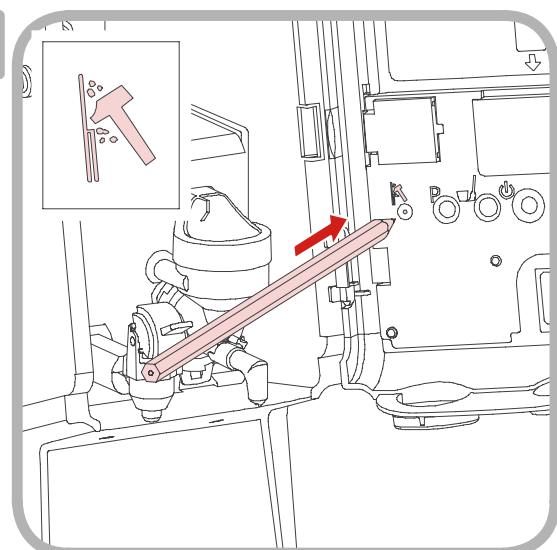



31.

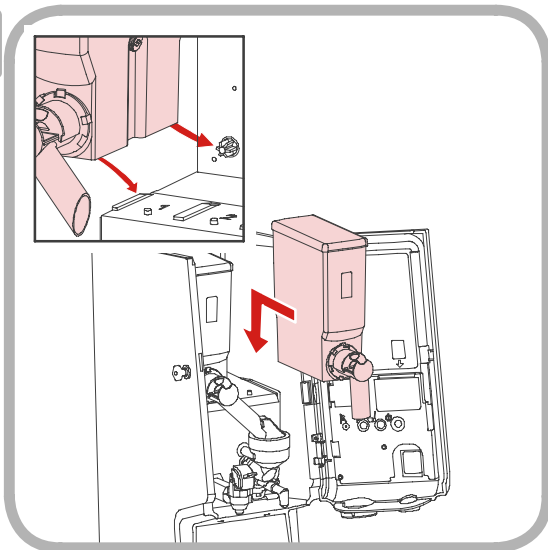

32.

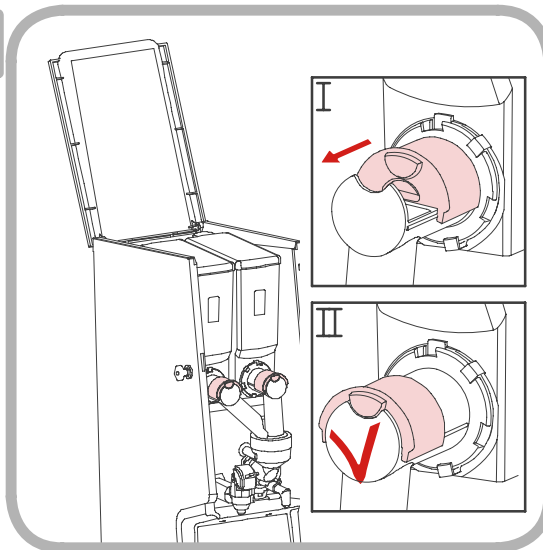

33.

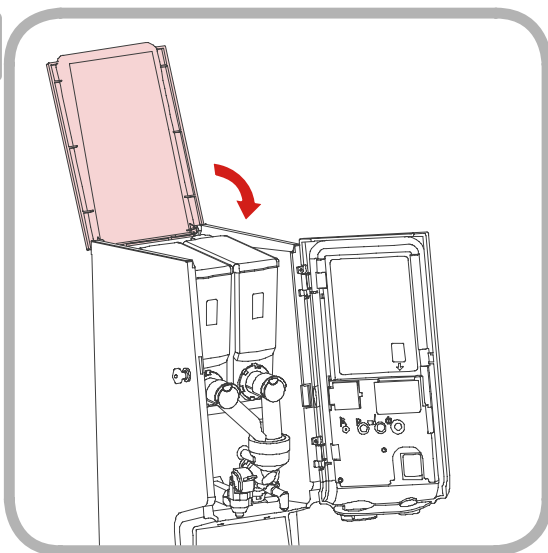

34.

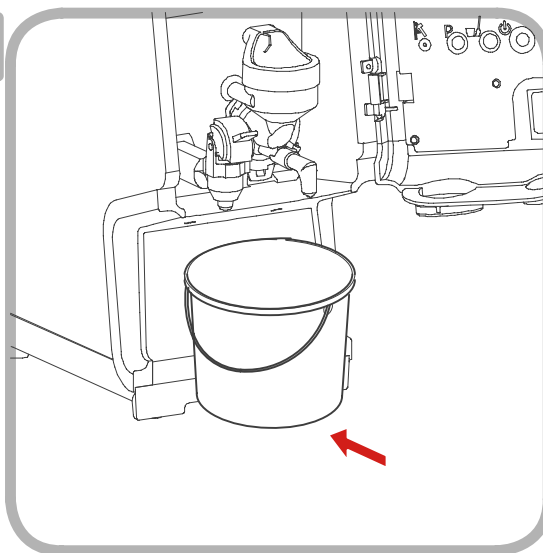

35.

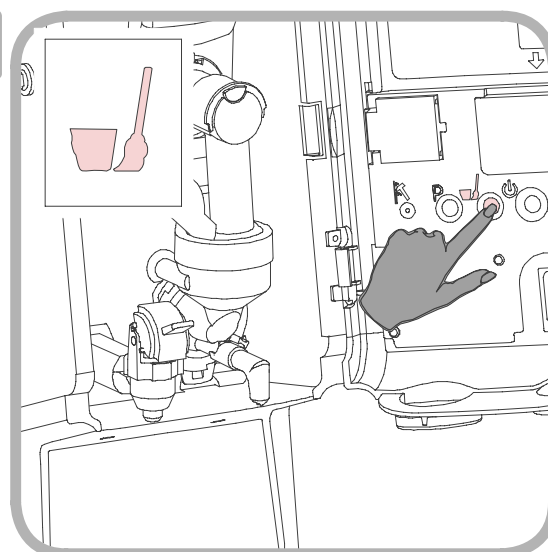

36.

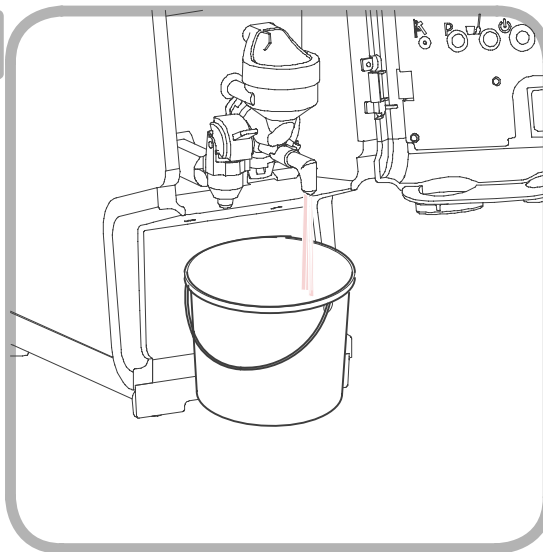



37.

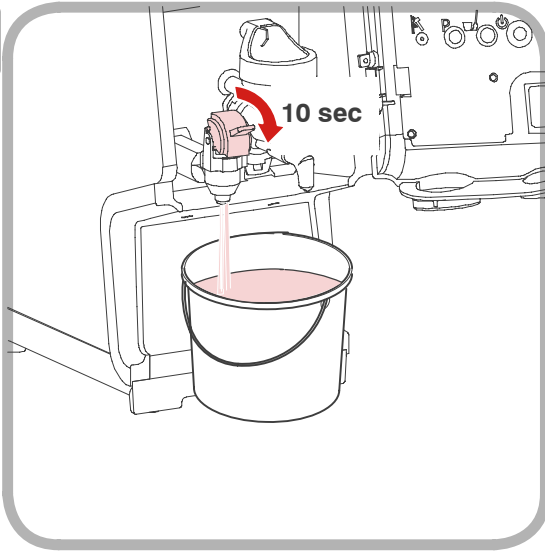

38.

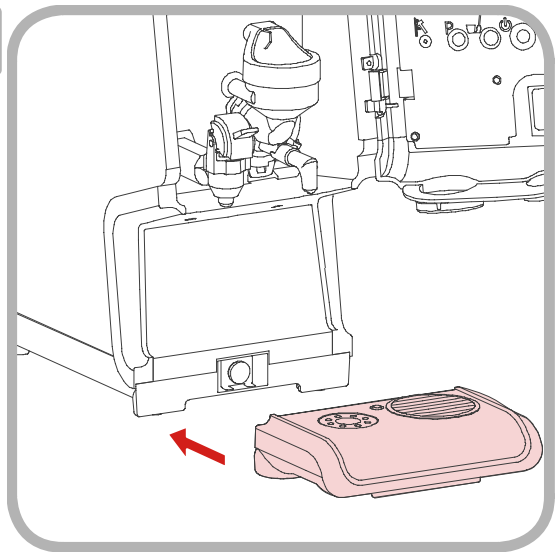

39.

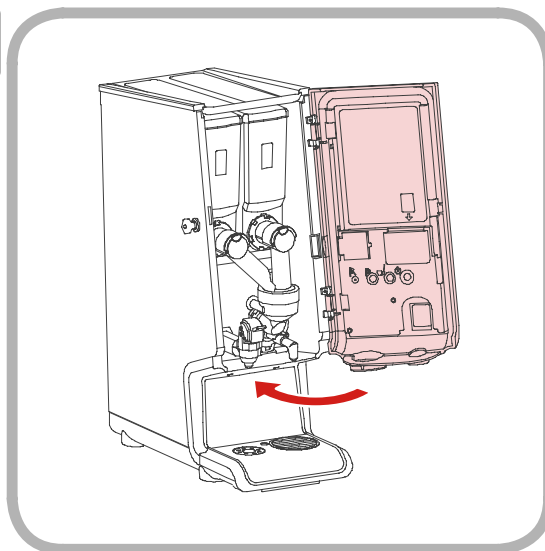

40.

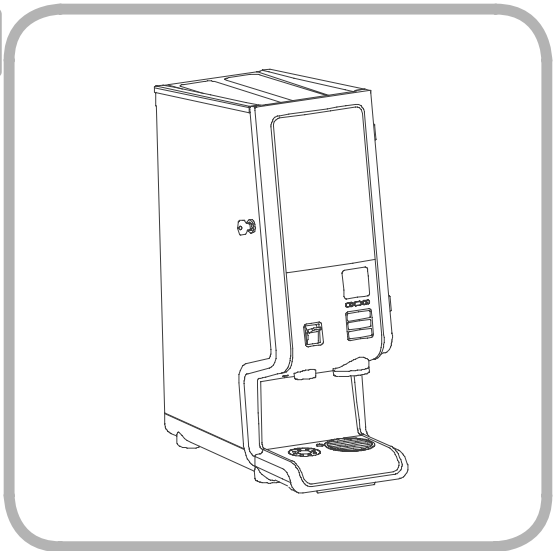

Head office

Bravilor Bonamat BV

Address : Pascalstraat 20
P.O.Box : 188
1700 AD Heerhugowaard
The Netherlands
Tel. : + 31 (0)72 57 51 751
Fax : + 31 (0)72 57 51 758
E-mail : sales@bravilor.com

Bonamat GmbH

Adresse : Brookstieg 14
D-22145 Stapelfeld
Deutschland
Tel. : (040) 60 823-0
Fax : (040) 60 823-100
E-mail : info.de@bonamat.com

Bravilor Ltd

Address : Unit 15 Cordwallis Park
Clivemont Road, Maidenhead
Berkshire SL6 7BU
United Kingdom
Tel. : (01628) – 776060
Fax : (01628) – 776035
E-mail : enquiries@bravilor.com

Bonamat Norge AS

Address : Kallerudlia 11
Postboks: 60
2801 Gjøvik
Norge
Tel. : 61 13 09 65
Fax : 61 13 09 75
E-mail : info.no@bonamat.com

Bonamat AB.

Adresse : Viggbyholmsvägen 83
18377 Täby
Sverige
Tel. : 08-622 64 50
Fax : 08-622 58 70
E-mail : info.se@bonamat.com

Bravilor Belux N.V.

Adres : Boomgaardreef 7
B2900 Schoten
Belgique / België
Tel. : (03) 663.77.22
Fax : (03) 663.77.44
E-mail : info.be@bravilor.com

Bravilor France S.A.S.

Adresse : 5, Rue Michel Carré
B.P. : N° 60034
95102 Argenteuil Cedex
France
Tél. : 01.34.34.47.74
Fax : 01.34.34.47.75
E-mail : info.fr@bravilor.com

Poland (Bravilor Bonamat BV)

Address : ul. Wankowicza 4/111
02-796 Warsaw
Poland
Tel. : (0)509-32 91 90
E-mail : info.pl@bravilor.com



Italiano
Ελληνικά
Česky
Polski
Română



Русский
Türkçe
中文
日本語
한글

Informazione Πληροφορίες Informace Informacja Informație		Информация Bilgi 資料 情報 알림	Elenco prodotti Πίνακας συστατικών Přehled směsí Lista składników Listă ingrediente		Список ингредиентов İçindekilerin listesi 成份清單 材料リスト 원재료 목록
Indice Περιεχόμενα Obsah Spis treści Index		Содержание İçindekiler 內容目錄 目次 목차	Attendere Αναμονή Čekejte Czekaj Așteaptă		Ждите Bekle 等候 待つ 기다림
Installazione Εγκατάσταση Instalace Instalacja Operare		Установка Yerleştirme 安裝 設置 설치	Guanti di protezione Γάντια ασφαλείας Ochranné rukavice Rękawiczki ochronne Mănuși protecție		Защитные перчатки Güvenlik eldivenleri 安全手套 安全手袋 안전용 장갑
Decalcificazione Αφαλάτωση Odvápnění Odkamienianie Decalcarizare		уистка от накипи Kireçten arındırma 除垢 데스케일 스케일 청소	Occhiali di protezione Γυαλιά ασφαλείας Ochranné brýle Okulary ochronne Ochelari protecție		Защитные очки Güvenlik gözlükleri 護目鏡 安全眼鏡 안전용 안경
Programmazione Προγραμματισμός λειτουργίας Programování Programowanie Programare		Программирование Programlama 程式 프로그래밍 프로그램	Liquido caldo Καυτό υγρό Horký nápoj Gorący płyn Lichid fierbinte		Горячая жидкость Sıcak sıvı 熱液體 熱水 더운 용액
Prescrizioni di sicurezza Έντυπο ασφαλείας Bezpečnostní kniha Wskazówki bezpieczeństwa Carte instructaj		Инструкция по эксплуатации Güvenlik kitabı 安全冊子 安全說明書 안전 지침서	Contatore Μετρητής Počítadlo Licznik Contor		Счетчик Sayaç 計數器 카운터 카운터
Manuale per l'utente Εγχειρίδιο χρήσης Provozní příručka Instrukcja obsługi Manualul utilizatorului		Руководство пользователя Kullanıcı kılavuzu 使用者手冊 유저-매뉴얼 카트리지	Accessori Εξαρτήματα Příslušenství Akcesoria Accesorii		Аксессуары Aksesuarlar 附件 備品 악세서리
			Opzione Προαιρετικό Nepovinný Opcja Opțional		Необязательный Opsiyonel 選擇 옵션 선택 사양





**/// BRAVILOR
BONAMAT**

© 05-2010

700.403.565B